

# CINDY

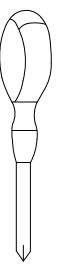

Teil	L	W	H	Pcs	Colli
1	110	153/173/193	16	1x	1/4
2	82	203	38	1x	2/4
3	82	203	38	1x	3/4

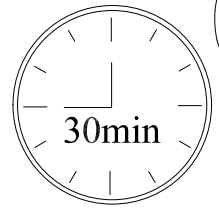
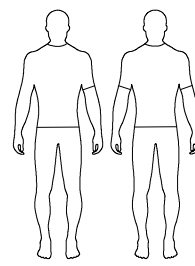
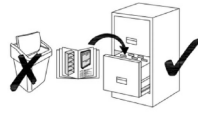
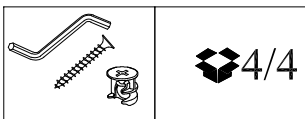
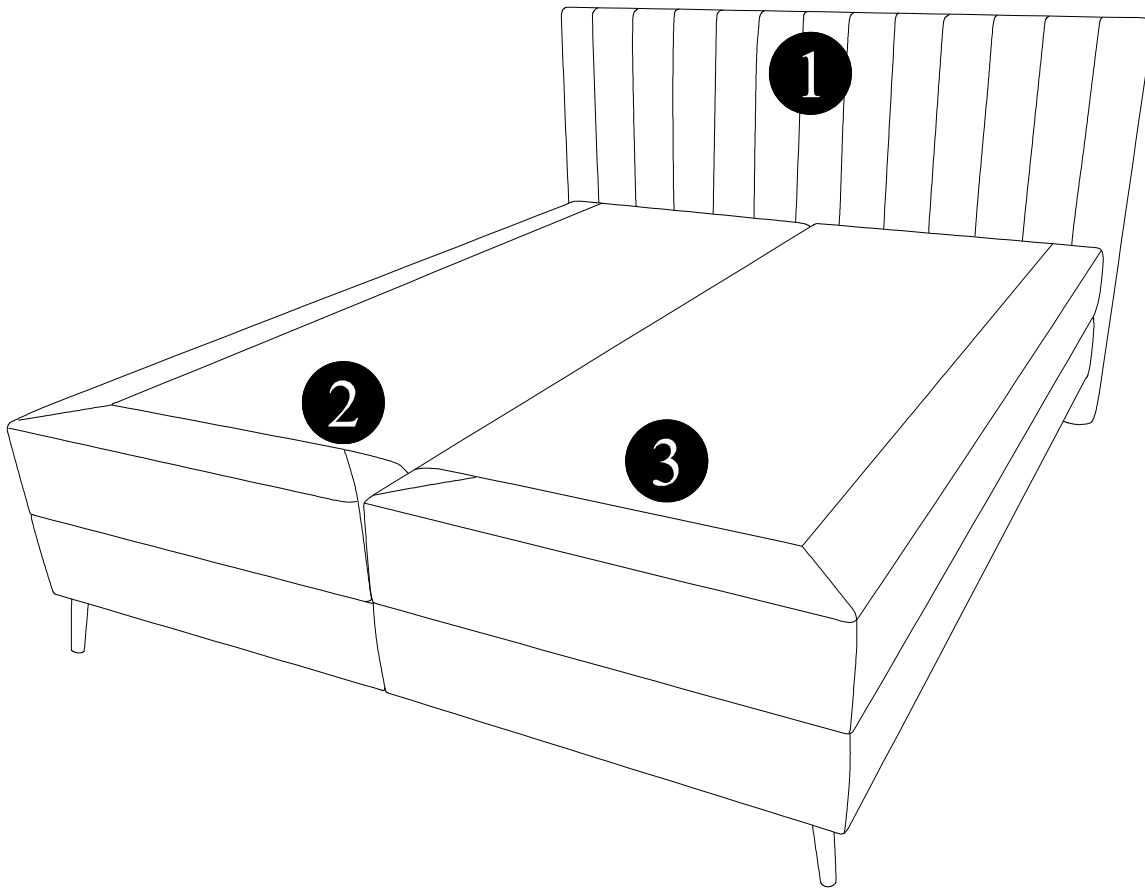

<b>A</b>		<b>B</b>		<b>C</b>		<b>D</b>		<b>E</b>		
	H-150	2x	H-150	6x	6X25	1x	H-150	1x	M6x80	4x
<b>F</b>		<b>G</b>								
	M6	4x	3,5x25	8x						

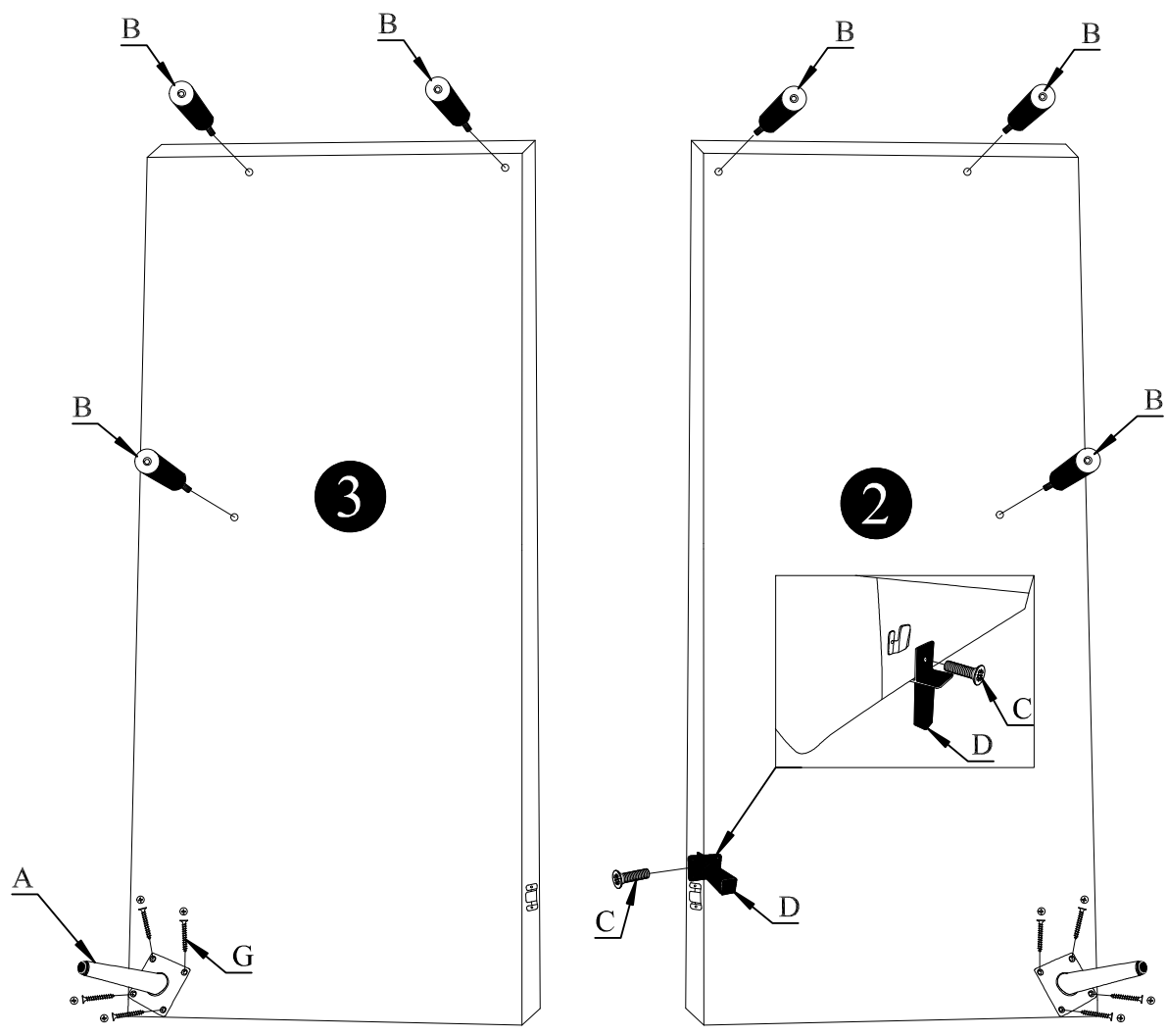

A	B	C	D	G
H-150	2x	H-150	6x	6X25
			1x	H-150
				1x
				3,5x25
				8x

1

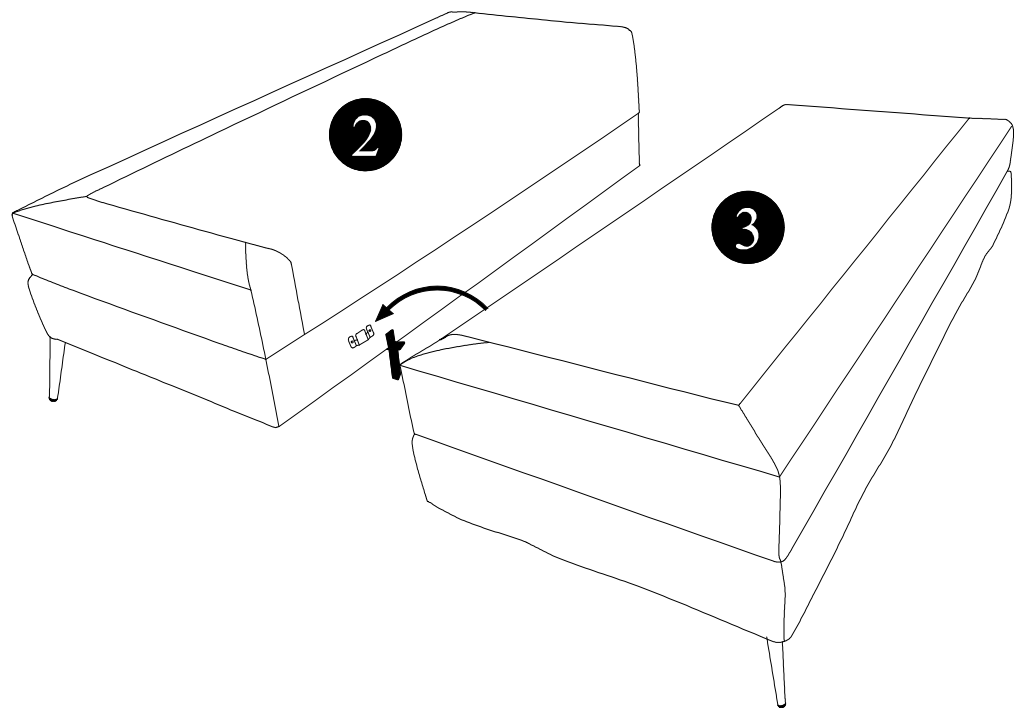

2

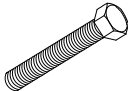

F		E	
M6x80	4x	M6	4x

3

